

9.1 MECHANICAL TERMINATION WITH COUNTER FLASHING

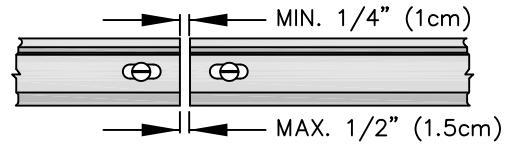
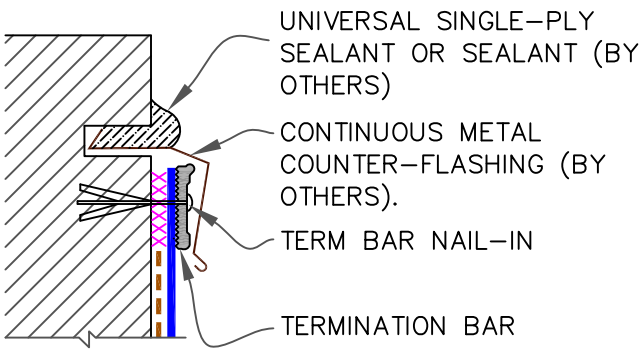

NOTES:

1. APPLY ON HARD SMOOTH SURFACE ONLY; NOT FOR USE ON EXPOSED WOOD.
2. DO NOT WRAP TERMINATION BAR AROUND CORNERS.
3. DETAIL 9.5 MUST BE USED AT VERTICAL JOINTS IN PANEL WALLS

9.2 SHEET METAL COPING (BY OTHERS)

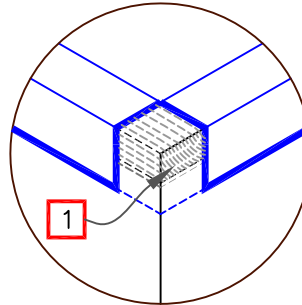
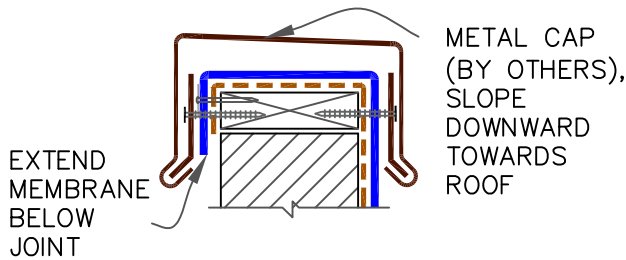

NOTE:

1. MEMBRANE MUST BE EXTENDED TO CORNERS TO PROVIDE COMPLETE COVERAGE OF THE TOP WALL SURFACE.

9.3 COUNTER FLASHING TERMINATION

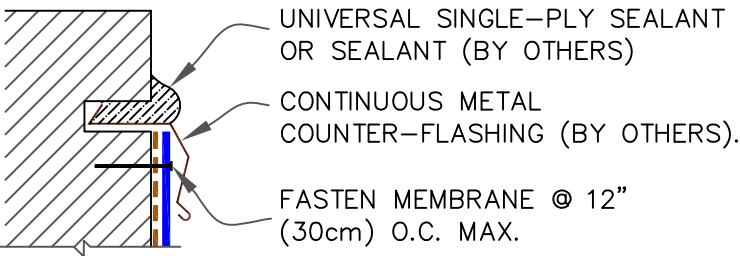

NOTE:

1. WHEN MECHANICAL FASTENERS ARE USED TO PENETRATE THE METAL COUNTER-FLASHING, USE EPDM WASHERS, APPLY WATER CUT-OFF MASTIC UNDER THE COUNTER-FLASHING OR CAULK THE FASTENER HEADS.

9.4 MECHANICAL TERMINATION

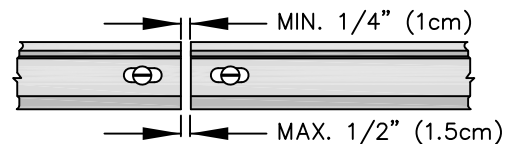
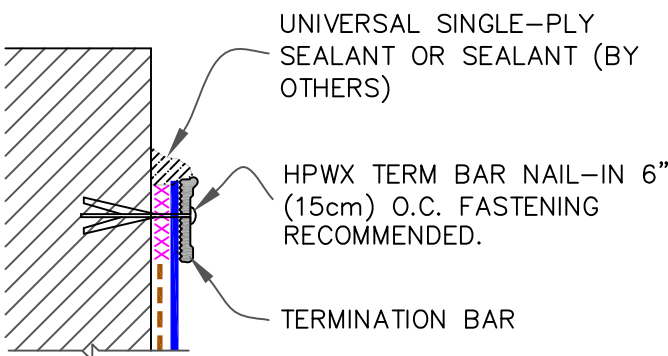

NOTES:

1. APPLY ON HARD SMOOTH SURFACE ONLY; NOT FOR USE ON EXPOSED WOOD.
2. DO NOT WRAP TERMINATION BAR AROUND CORNERS.
3. DETAIL 9.5 MUST BE USED AT VERTICAL JOINTS IN PANEL WALLS.

--- APPLICABLE BONDING ADHESIVE

xxx WATER CUT-OFF MASTIC- MUST BE HELD UNDER CONSTANT COMPRESSION.

